

2020

SUMMER

NEW PRODUCTS



A close-up photograph of a Sangeo cutting tool. The tool is primarily silver-colored with a polished finish. It features a cylindrical upper section and a more complex, multi-faceted lower section. The lower section has several sharp, pointed edges and is secured with three screws. The brand name "Sangeo" is printed in a bold, sans-serif font on the upper section, with the tagline "cutting tools" in a smaller font below it. The tool is resting on a light-colored, reflective surface, which creates a clear reflection of the tool's base. The background is blurred, showing a dark blue wall and a white surface.

Sangeo
cutting tools

Sangeo cutting tools

LNGX

4

PNMU

5

XDHX

6

HNGX



7

NEGATIVE
with hole

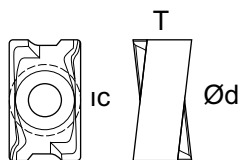
LNGX



LNGX	1104	15T6
IC	6,60	10,00
T	4,83	6,96
Ød	12,0	16,9
Holder	9-10-11	

DESCRIPTION			CARBIDE														
			PS5915	PS5925	PS5960	CS8915	CS8925	PS7925	US2915								
	LNGX	110408RSE	•						•								
	LNGX	15T608RSE	•						•								

MILLING

NEGATIVE 45°
with hole

PNMU

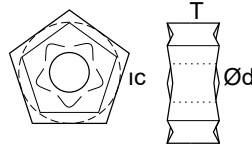

PNMU 0905

IC 14,60

T 5,56

Ød 4,7



12 - 13

DESCRIPTION			CARBIDE										
			PS5915	PS5925	PS5960	CS8915	CS8925	PS7925	US2915				
	PNMU	0905XNER-MM	•						•				

Vc • fn • ap



8

POSITIVE
with hole

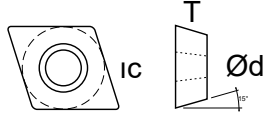
XDHX



XD	0602	10T3
IC	6,5	10
T	2,38	3,97
Ød	2,8	4
Holder	14	14

DESCRIPTION			CARBIDE														
			PS5915	PS5925	PS5960	CS8915	CS8925	PS7925	US2915								
	XDHX	060210-SS	•						•								
	XDHX	10T310-SS	•						•								

MILLING

NEGATIVE 45°
with hole

HNGX

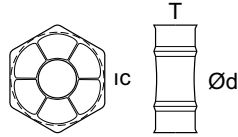

HNMX 0906



IC 14,60

T 5,56

Ød 4,7



14

DESCRIPTION			CARBIDE										
			PS5915	PS5925	PS5960	CS8915	CS8925	PS7925	US2915				
	HNGX	0906ANSN-R	•						•				
	HNGX	0906ANSN-F	•						•				

Vc • fn • ap

8

Cutting Parameters ap (mm) & fn (mm/rev)

LNGX		1104	15T6			
-------------	---	-------------	-------------	--	--	--

Material	Chip Breaker	ap (mm)	fn (mm/rev)	ap (mm)	fn (mm/rev)	ap (mm)	fn (mm/rev)	ap (mm)	fn (mm/rev)	ap (mm)	fn (mm/rev)
K											
P	FH	1,00~11,00	100~230	1,5~15,00	100~230						
M	FH	1,00~11,00	100~200	1,5~15,00	100~200						
N											

PNMU		0905				
-------------	---	-------------	--	--	--	--

Material	Chip Breaker	ap (mm)	fn (mm/rev)	ap (mm)	fn (mm/rev)	ap (mm)	fn (mm/rev)	ap (mm)	fn (mm/rev)	ap (mm)	fn (mm/rev)
K											
P	MM	0,8~4,0	120~250								
M	MM	0,8~4,0	100~220								
N											

XDHX		0602	10T3			
-------------	---	-------------	-------------	--	--	--

Material	Chip Breaker	ap (mm)	fn (mm/rev)	ap (mm)	fn (mm/rev)	ap (mm)	fn (mm/rev)	ap (mm)	fn (mm/rev)	ap (mm)	fn (mm/rev)
K											
P	SS	0,5~1,0	140~280	0,5~1,5	140~270						
M	SS	0,5~1,0	140~220	0,5~1,5	140~220						
N											

HNGX		0906				
-------------	---	-------------	--	--	--	--

Material	Chip Breaker	ap (mm)	fn (mm/rev)	ap (mm)	fn (mm/rev)	ap (mm)	fn (mm/rev)	ap (mm)	fn (mm/rev)	ap (mm)	fn (mm/rev)
K											
P	R - F	0,8~4,5	180~250								
M	R - F	0,8~4,5	180~250								
N											

MFLN

LNGX

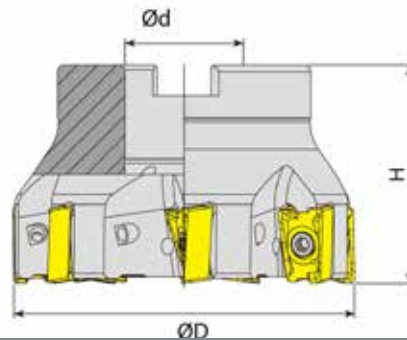



LN	DESCRIPTION	STOCK	DIMENSIONS									
			D	H	d	Z	ap					
LN 11	MFLN	MFLN-040R-11-6T-C	●	40	40	16	6	11			ST-SC0360	ST-WRT08
		MFLN-040R-11-7T-C	●	40	40	16	7	11			ST-SC0360	ST-WRT08
		MFLN-050R-11-7T-C	●	50	40	22	7	11			ST-SC0360	ST-WRT08
		MFLN-050R-11-9T-C	●	50	40	22	9	11			ST-SC0360	ST-WRT08
		MFLN-063R-11-7T-C	●	63	40	22	7	11			ST-SC0360	ST-WRT08
		MFLN-063R-11-9T-C	●	63	40	22	9	11			ST-SC0360	ST-WRT08
		MFLN-080R-11-8T-C	●	80	50	27	8	11			ST-SC0360	ST-WRT08
		MFLN-080R-11-10T-C	●	80	50	27	10	11			ST-SC0360	ST-WRT08
LN15	MFLN	MFLN-040R-15-4T-C	●	40	40	16	4	15,5			ST-SC0411	ST-WRT15
		MFLN-040R-15-5T-C	●	40	40	16	5	15,5			ST-SC0411	ST-WRT15
		MFLN-050R-15-5T-C	●	50	40	22	5	15,5			ST-SC0411	ST-WRT15
		MFLN-050R-15-6T-C	●	50	40	22	6	15,5			ST-SC0411	ST-WRT15
		MFLN-063R-15-6T-C	●	63	40	22	6	15,5			ST-SC0411	ST-WRT15
		MFLN-063R-15-7T-C	●	63	40	22	7	15,5			ST-SC0411	ST-WRT15
		MFLN-080R-15-7T-C	●	80	50	27	7	15,5			ST-SC0411	ST-WRT15
		MFLN-080R-15-9T-C	●	80	50	27	9	15,5			ST-SC0411	ST-WRT15
		MFLN-100R-15-8T-C	●	100	50	32	8	15,5			ST-SC0411	ST-WRT15
		MFLN-100R-15-11T-C	●	100	50	32	11	15,5			ST-SC0411	ST-WRT15
		MFLN-125R-15-9T-C	●	125	63	40	9	15,5			ST-SC0411	ST-WRT15
		MFLN-125R-15-12T-C	●	125	63	40	12	15,5			ST-SC0411	ST-WRT15
		MFLN-160R-15-12T-C	●	160	63	40	12	15,5			ST-SC0411	ST-WRT15

MMLN

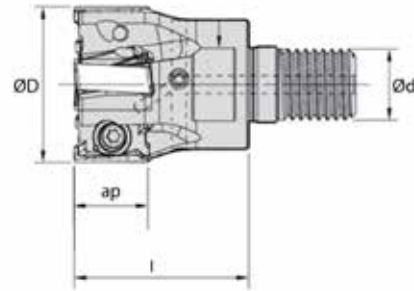
LNGX



LN	DESCRIPTION	STOCK	DIMENSIONS							 ← 		
			D	ap	l	d	Z					
LN 11	MMLN	MMLN-16-M08-11-2T-C	●	16	11	25	13	2			ST-SC0360	ST-WRT08
		MMLN-20-M10-11-3T-C	●	20	11	28	18	3			ST-SC0360	ST-WRT08
		MMLN-25-M12-11-4T-C	●	25	11	40	21	4			ST-SC0360	ST-WRT08
		MMLN-32-M16-11-5T-C	●	32	11	40	29	5			ST-SC0360	ST-WRT08
		MMLN-40-M16-11-6T-C	●	40	11	40	29	6			ST-SC0360	ST-WRT08
LN 15	MMLN	MMLN-25-M12-15-2T-C	●	25	15	32	21	2			ST-SC0411	STWRT15
		MMLN-32-M16-15-3T-C	●	32	15	40	29	3			ST-SC0411	STWRT15
		MMLN-35-M16-15-4T-C	●	35	15	40	29	4			ST-SC0411	STWRT15
		MMLN-40-M16-15-5T-C	●	40	15	40	29	5			ST-SC0411	STWRT15

MSLN

LNGX

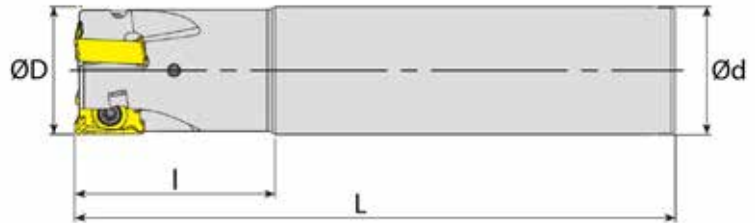



LN	DESCRIPTION	STOCK	DIMENSIONS											
			D	L	l	d	Z	ap						
LN 11	MSLN	MSLN-16-100-11-16-2T-C	●	16	100	25	16	2	11				ST-SC0360	ST-WRT08
		MSLN-16-150-11-16-2T-C	●	16	150	25	16	2	11				ST-SC0360	ST-WRT08
		MSLN-20-100-11-20-3T-C	●	20	100	28	20	3	11				ST-SC0360	ST-WRT08
		MSLN-20-140-11-20-3T-C	●	20	150	28	20	3	11				ST-SC0360	ST-WRT08
		MSLN-25-150-11-25-4T-C	●	25	150	43	25	4	11				ST-SC0360	ST-WRT08
		MSLN-25-200-11-25-4T-C	●	25	200	43	25	4	11				ST-SC0360	ST-WRT08
		MSLN-32-150-11-32-5T-C	●	32	150	49	32	5	11				ST-SC0360	ST-WRT08
		MSLN-32-200-11-32-5T-C	●	32	200	49	32	5	11				ST-SC0360	ST-WRT08
		MSLN-40-200-11-32-5T-C	●	40	200	49	32	5	11				ST-SC0360	ST-WRT08
LN 15	MSLN	MSLN-25-100-15-25-2T-C	●	25	100	43	25	2	15				ST-SC0411	STWRT15
		MSLN-25-150-15-25-2T-C	●	25	150	43	25	2	15				ST-SC0411	STWRT15
		MSLN-25-200-15-25-2T-C	●	25	200	43	25	2	15				ST-SC0411	STWRT15
		MSLN-32-150-15-32-3T-C	●	32	150	49	32	3	15				ST-SC0411	STWRT15
		MSLN-32-200-15-32-3T-C	●	32	200	50	32	3	15				ST-SC0411	STWRT15
		MSLN-40-150-15-32-4T-C	●	40	150	49	32	4	15				ST-SC0411	STWRT15
		MSLN-40-200-15-32-4T-C	●	40	200	50	32	4	15				ST-SC0411	STWRT15

MFPN

45°

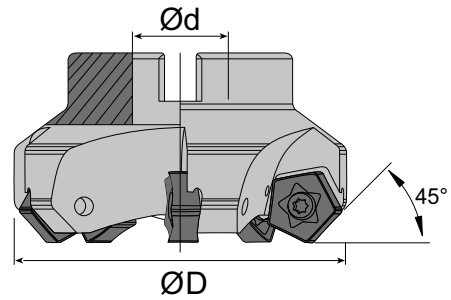
PNMU





PN	DESCRIPTION	STOCK	DIMENSIONS									
			D	H	d	ap	Z					
PN	MFPN	● 45050R-4T-C	50	40	22	5	4	ST-SC0411	ST-WRT15			
		● 45063R-5T-C	63	45	22	5	5	ST-SC0411	ST-WRT15			
		● 45080R-6T-C	80	50	27	5	6	ST-SC0411	ST-WRT15			
		● 45100R-7T-C	100	50	32	5	7	ST-SC0411	ST-WRT15			

MFPN

66°

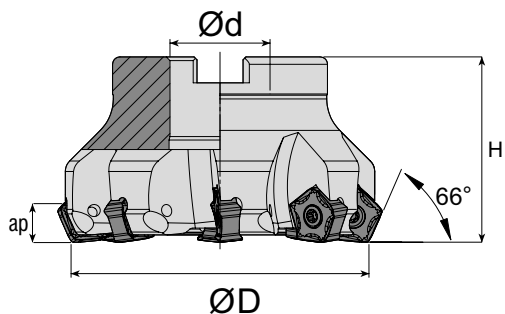
PNMU





PN	DESCRIPTION	STOCK	DIMENSIONS								
			D	H	d	ap	Z				
PN	MFPN	●	66063R-5TC	63	45	22	5	5	ST-SC0411	ST-WRT15	
		●	66080R-6TC	80	50	27	5	6	ST-SC0411	ST-WRT15	
		●	66100R-7TC	100	50	32	5	7	ST-SC0411	ST-WRT15	
		●	66125R-9TC	125	50	40	5	9	ST-SC0411	ST-WRT15	

MMXD

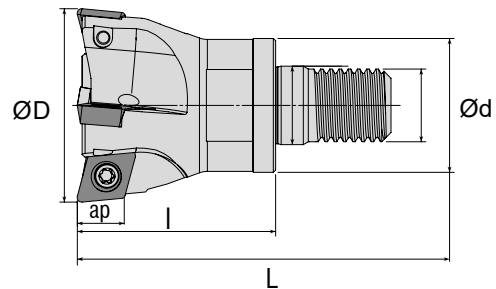
XD□□





XD	DESCRIPTION	STOCK	DIMENSIONS					 ← 			
			D	H	d	ap	Z				
XD 06	16-M08-06-2T-C	●	16	52	M08	1,0	2	ST-SC0256	ST-WRT08		
	20-M10-06-3T-C	●	20	52	M10	1,0	3	ST-SC0256	ST-WRT08		
	25-M12-06-3T-C	●	25	52	M12	1,0	3	ST-SC0256	ST-WRT08		
XD 10	35-M16-10-3T-C	●	35	64	M16	1,5	3	ST-SC3508	ST-WRT15		
	42-M16-10-4T-C	●	42	67	M16	1,5	4	ST-SC3508	ST-WRT15		

MFHN

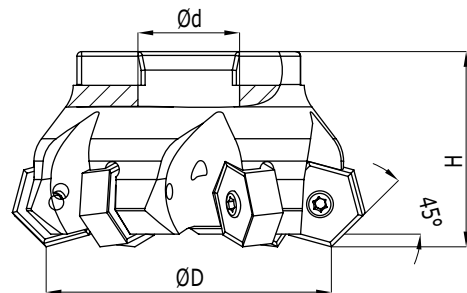
HNGX



HN	DESCRIPTION	STOCK	DIMENSIONS				 ← 			
			D	H	d	Z				
HN	45050R-4T-C	●	50	40	22	4	ST-SC0411	ST-WRT15		
	45063R-4T-C	●	63	40	22	4	ST-SC0411	ST-WRT15		
	45080R-6T-C	●	80	50	27	6	ST-SC0411	ST-WRT15		
	45100R-8T-C	●	100	50	32	8	ST-SC0411	ST-WRT15		
	45125R-10T-C	●	125	62	40	10	ST-SC0411	ST-WRT15		
	45160R-12T-C	●	160	62	40	12	ST-SC0411	ST-WRT15		
	45200R-10T-C	●	200	62	60	10	ST-SC0411	ST-WRT15		

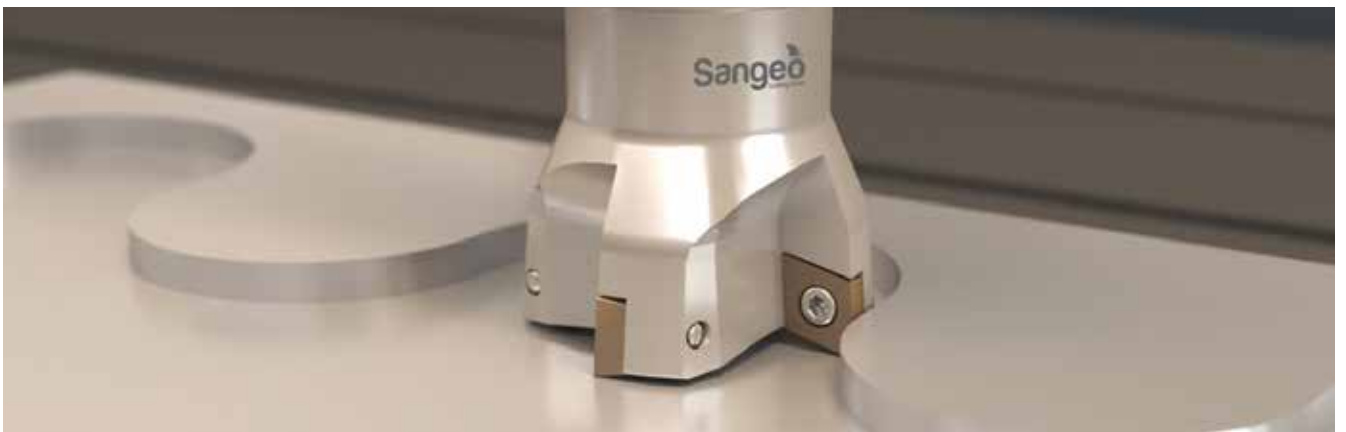
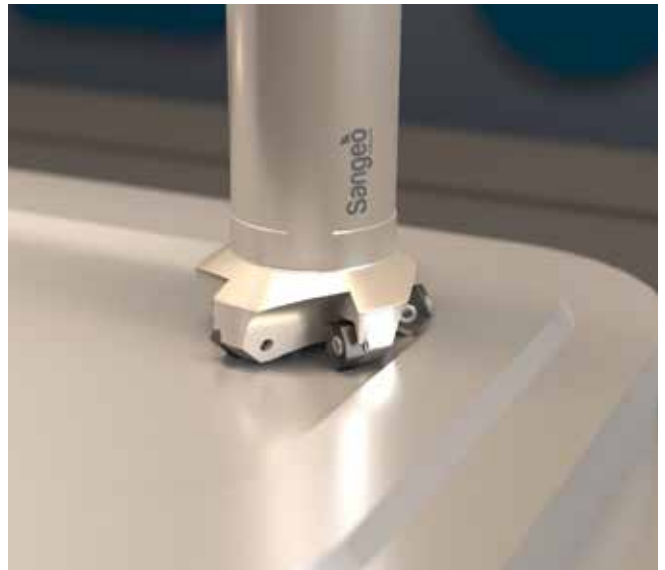
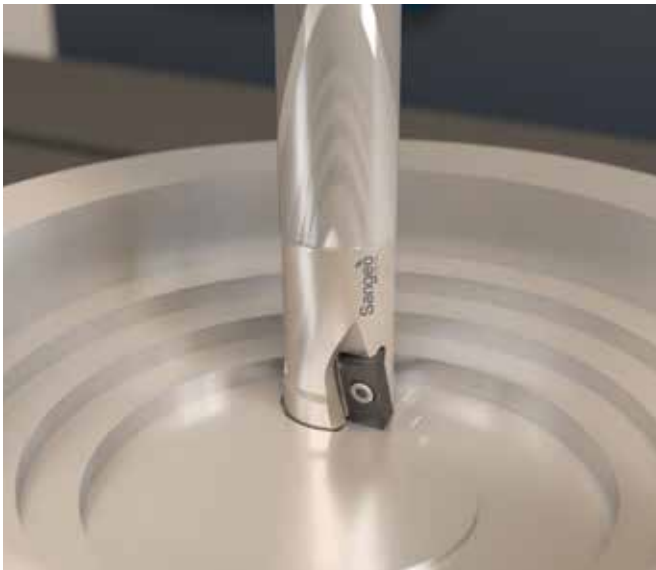



Sangeo
cutting tools



HEAD OFFICE

Sangeo Metal İşleme Ürünler Dış Tic. Ltd. Şt.
Şekerpınar mah. Nergis sok. Akpınar Plaza No:2/107 Çayırova/Kocaeli - Turkey
TEL : +90 850 532 05 83 FAX : +90 212 924 54 56
info@sangeo.com.tr www.sangeo.com.tr